

SLEWING JIB CRANES





Ivan Muri, CEO As a Swiss manufacturer with fully automated production, we are loyal to the location Switzerland. The high functionality, long life and robustness of our products help our customers to avoid operational interruptions which can cause high follow-on costs. With our own development and design department, we ensure long-term innovation power. Suppliers from Switzerland and its neighbour countries guarantee the reliability and quality we demand.



Erich Widmer, Sales and Marketing Manager From project planning to installation, we support our customers with advice and assistance. As a system supplier of complete crane systems, we can respond to specific customer demands. Our customers particularly value the variety of accessories and options. Our high product quality and readiness to deliver make us a reliable and competent partner worldwide.



SIMPLE AND ECONOMIC



GIS pillar- and wall-mounted slewing jib cranes offer a simple and functional solution for ergonomic goods handling. Depending on the desired load capacity, the jib working radius and the running properties, aluminium or steel profiles are used. In combination with a GIS electric chain hoist and a trolley (manual or electric), a GIS vacuum-handling system or another load-handling device, you get a complete crane system from one source – directly from the Swiss manufacturer.

GIS slewing jib cranes – customised and flexible

PILLAR-MOUNTED SLEWING JIB CRANES



In cooperation with our customers, we develop individual solutions for a functional workplace design. GIS slewing jib cranes are designed as customer-specific or standard products. The installation is carried out according to our customer's requirements: on the floor, on the ceiling or on a concrete base for mobile operation. Our pillar-mounted slewing jib cranes are sturdy, easy to install and designed in accordance with the latest EU Machinery Directive DIN15018.

GISKB steel hollow profile

Lifting capacity up to 1000 kg

Higher lifting capacities on request

Steel jib profile GISKB

Treads inside the profile protected from dirt

Trolley with smoothly running plastic rollers

Slewing range up to 270°

Jib length up to 6 m, longer jibs on request

Option: equipped with an electric tug

Option: equipped with a telescope

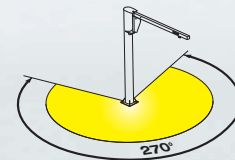

YOUR BENEFITS

GIS pillar-mounted slewing jib cranes have a slewing range up to 270° or even 330° in case of articulated jib cranes. For smaller loads up to 500 kg, an overhead or slewing jib crane made of aluminium profiles is suitable due to its smooth running. For higher lifting capacities we recommend a more cost-efficient solution with hollow profiles or IPE beams made of steel.





GISKB aluminium hollow profile

Lifting capacity up to 500 kg

Higher lifting capacities on request

Aluminium jib profile GISKB Alu

Treads inside the profile protected from dirt

Perfect smooth running during turning and longitudinal travel

Slewing range up to 270°

Jib length up to 6 m, longer jibs on request

GSD-TR steel pipe profile

Lifting capacity up to 250 kg

Higher lifting capacities on request

Articulated jib crane with max. slewing range

Suitable for eccentric load suspension with GIS handy telescope

Slewing range up to 270° (inside), or up to 330° (outside)

Jib length up to 2.6 m, longer jibs on request

Option: equipped with a brake at the inner and outer joint

IPE steel beam

Lifting capacity up to 5000 kg

Higher lifting capacities on request

Steel jib beam IPE

Slewing range up to 360°

Jib length up to 12 m, longer jibs on request

Option: equipped with a telescope

Option: equipped with trolley and slewing system electric

Option: equipped with radio control

Option: equipped with weather-protection package

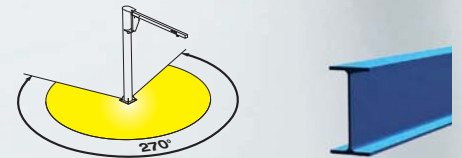
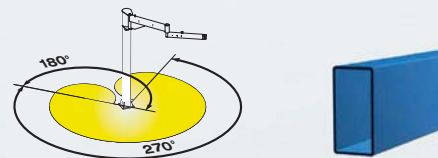
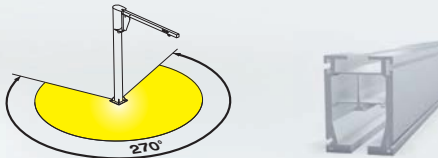

WALL-MOUNTED SLEWING JIB CRANES



GIS wall-mounted slewing jib cranes are a cost-efficient alternative to pillar-mounted slewing jib cranes or complete crane systems. The key benefit of wall-mounted slewing jib cranes is that they do not require any floor space, since they are mounted to stable concrete walls or existing pillars. Our wall-mounted slewing jib cranes are sturdy, easy to install and designed in accordance with the latest EU Machinery Directive DIN15018.

GISKB steel hollow profile

Lifting capacity up to 1000 kg

Higher lifting capacities on request

Steel jib profile GISKB

Treads inside the profile protected from dirt

Trolley with smoothly running plastic rollers

Slewing range up to 180°

Jib length up to 6 m, longer jibs on request

Option: equipped with pillar clasp

Option: equipped with an electric tug

Option: equipped with a telescope

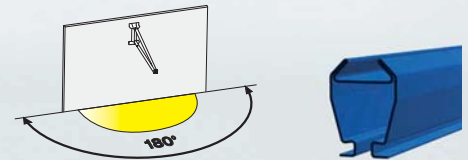

YOUR BENEFITS

GIS wall-mounted slewing jib cranes have a slewing range up to 180° or even 330° in case of articulated jib cranes. For smaller loads up to 500 kg, an overhead or slewing jib crane made of aluminium profiles is suitable due to its smooth running. For higher capacities we recommend a more cost-efficient solution with hollow profiles or IPE beams made of steel.





GISKB aluminium hollow profile

Lifting capacity up to 500 kg

Higher lifting capacities on request

Aluminium jib profile GISKB Alu

Treads inside the profile protected from dirt

Perfect smooth running during turning and longitudinal travel

Slewing range up to 180°

Jib length up to 6 m, longer jibs on request

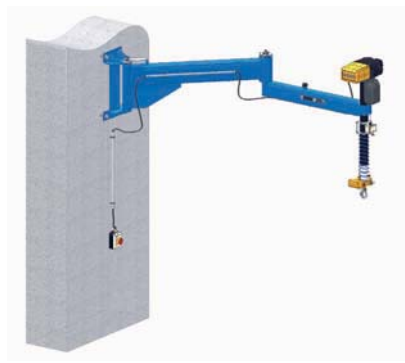
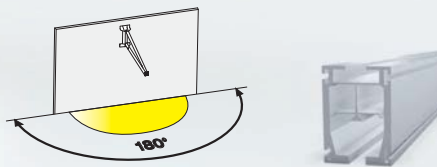

GWD-TR steel pipe profile

Lifting capacity up to 250 kg

Higher lifting capacities on request

Articulated jib crane with max. slewing range

Suitable for eccentric load suspension with GIS handy telescope

Slewing range up to 180° (inside), or up to 330° (outside)

Jib length up to 2.6 m, longer jibs on request

Option: equipped with a brake at the inner and outer joint

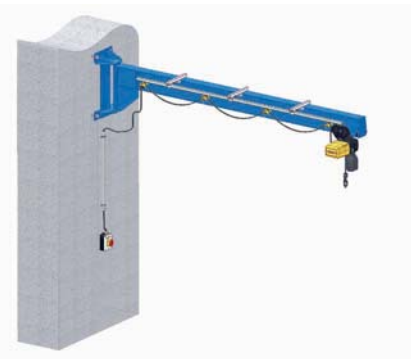
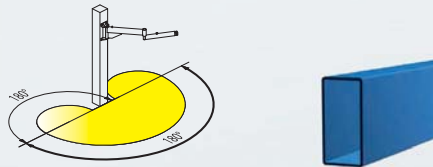

IPE steel beam

Lifting capacity up to 5000 kg

Higher lifting capacities on request

Steel jib beam IPE

Overhead jib

Slewing range up to 180°

Jib length up to 12 m, longer jibs on request

Option: equipped with a telescope

Option: equipped with trolley and slewing system electric

Option: equipped with radio control

Option: equipped with weather-protection package

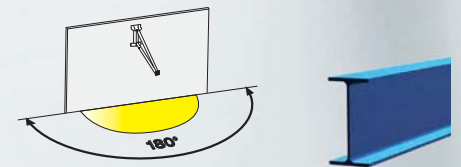

USE



We are a specialist for customer-specific system solutions and we are building on decades of experience of crane construction and ergonomic goods handling. Slewing jib cranes with special jib lengths, for mobile operation or for outdoor use are daily business for design engineers at GIS. Whether in the automotive industry, the food industry or in a hazardous environment, we find the perfect solution for the requirements in your field of application.

Mobile slewing jib crane

Lifting capacity up to 250 kg

- Higher lifting capacities on request
- Easy to transport
- Use at different locations
- Pillar of slewing jib crane with a concrete base
- No anchorage on the floor
- Slewing range up to 270°
- Jib length on request
- Jib made of GISKB steel or aluminium hollow profile or IPE steel beam

SFS INTEC AG

Marco Heule, Heerbrugg, Switzerland
Team leader Mechanics Service MES

The mobile slewing jib crane allows us to handle loads at different locations. We appreciate this mobility in case of temporary workplaces or workplaces to be set up, but also in case of machine reconstructions and repairs. GIS offered us a solution tailored to our needs that we are very satisfied with.





Food industry

Corrosion-resistant design

Aluminium profile, steel profile hot-dip galvanised or with finishing coat

Electric chain hoist and trolley corrosion resistant version

Special food-safe grease

Use in bakeries, dairies or other businesses in the food-processing industry

Option: available with protection class IP65

Outdoor use

Weatherproof version

Aluminium profile, steel profile hot-dip galvanised or with finishing coat

Electric chain hoist protection class IP65

Trolley protection class IP65

Option: available with object-specific covers

Option: available with special coating

Option: equipped with radio control

ATEX use

Explosion-proof version

Electric chain hoist and trolley in ATEX version with compressed-air and temperature monitoring

Equipment group II, equipment category 3, zone 22, substance group D

Option: equipped with radio control



INSTALLATION

The GIS slewing jib crane product range is very diverse, and so are the mounting options. Existing walls, pillars or concrete floors are taken into account during the project planning of the slewing jib crane with regard to the subsequent installation. Bearing in mind the load capacity and the jib length, the appropriate mounting points are determined.

Our goal: The perfect goods handling at the workplace.

Composite technology

The anchoring or dowelling technique is perfectly suitable for resilient concrete floors, walls or ceilings.

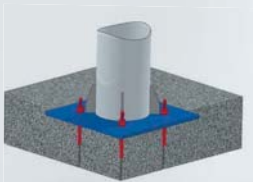

Anchoring technique for floor mounting

Clasp

Ideal approach to the solution in case of concrete or steel pillars: frontally or around corners.

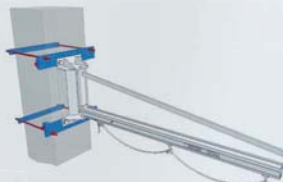

Classic clasp on frontal, rectangular pillar shape

Counter plate

Distributes the force transmission in «sandwich»-load shared on a larger surface.

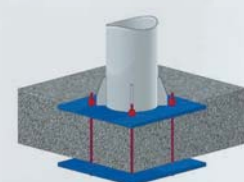

Floor plate for floor mounting

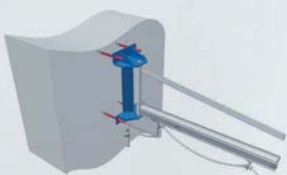

Dowelling technique for wall and ceiling mounting



Fastening around corners



Wall mounting

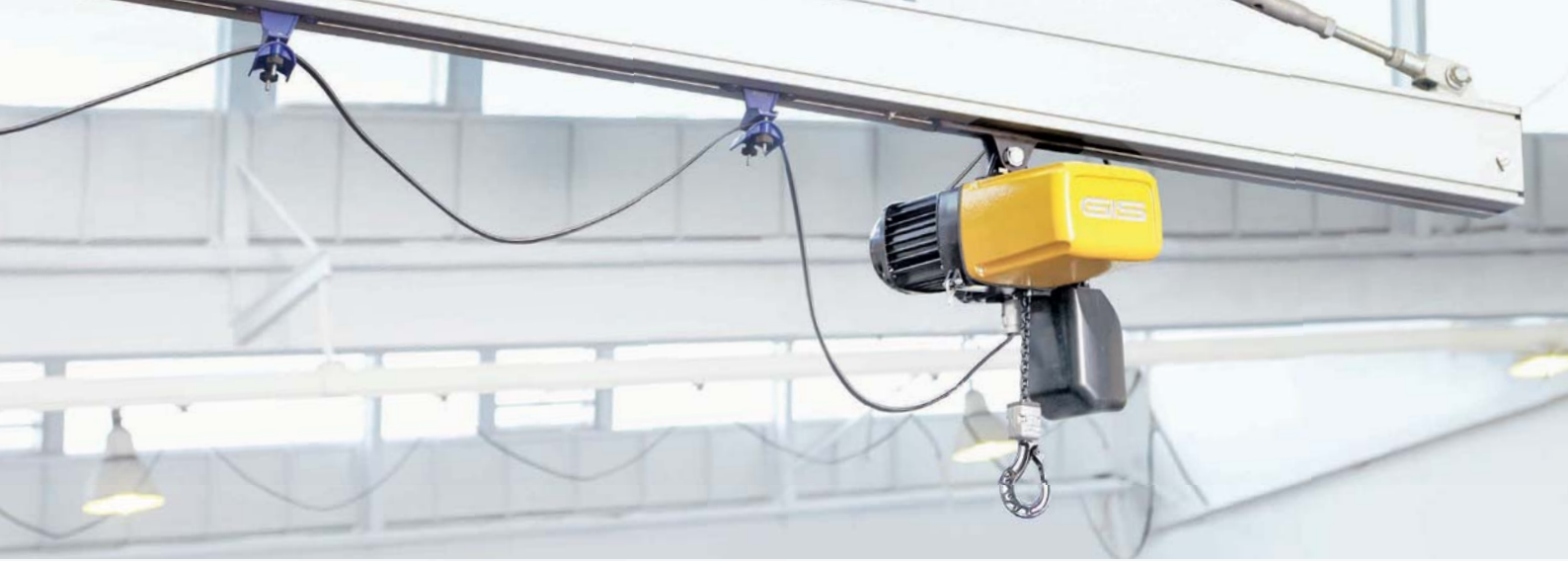

Standard version

Lifting capacity range 80 – 1000 kg
Standard paint primed RAL 7035
Slewing jib crane and lifting gear for indoor operation
GIS electric chain hoist as lifting device
Manual or electric trolley
Power supply through trailing cable
Limit stop for trolley
Pillar height up to 4.2 m
Jib lengths up to 6 m
Wall or floor mounting

Accessories and options

Lifting capacities exceeding 1000 kg
Radio control or roving pendant
Special paints or galvanised version
Slewing jib crane and hoisting equipment for outdoor operation
ATEX version for potentially explosive environment
Special jib lengths
Special pillar heights
Mounting on existing pillar or ceiling
Pillar-mounted slewing jib crane 360° powered electrically
Slewing jib cranes with telescopic jib
Swivel limitations
GIS manual chain hoist as lifting device
Frequency-controlled drives

Power supply

Trailing cable

Standard version

Cable trolley inside profile
For contaminated or humid environment
Cost-efficient solution
Suitable for outdoor use
Option: equipped with compressed-air supply

C-rail

With trailing cable

For contaminated or humid environment
Using the entire travel range
Suitable for outdoor use
Option: equipped with compressed-air supply

Conductor line

External

Space-saving (no hanging cables)
Ideal approach dimensions
Aesthetic solution
Option: available with internal conductor line



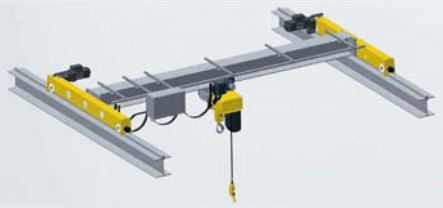

Crane systems

GISKB steel crane construction kit for line-bound or all-round goods handling. GISKB aluminium crane system, slewing pillar and wall cranes for smooth handling of transport goods. Travelling cranes and slewing cranes made of steel profiles for heavier loads.

Hoisting equipment

Over 50 years experience in the manufacture of electric chain hoists: robust, durable, reliable and highly resistant to wear. Simple maintenance. Various special versions for every application area. Wide range of accessories and options.

Vacuum handling systems

GIS vacuum handling systems for the ergonomic and gentle handling of goods made of different materials like wood, glass, stone, metal or plastic. In combination with the appropriate crane system.

GIS AG – the specialist for crane systems Founding of the GIS AG in 1957 | With own subsidiary in Germany since 1966 | Development and production of electric chain hoists in Switzerland for over 50 years | Swiss manufacturer of complete crane systems inc. hoisting equipment and vacuum lifters | Certified to ISO 9001 since 1994 | Complete market services from project planning to installation, start-up and maintenance | International sales network with over 50 qualified partners worldwide

Swiss Lifting Solutions

Certified to ISO 9001