

Compact electric rope winch PLA-B

PLA-B is concipated as a pulling winch, but can also lift and hold loads with an integrated brake. Since there are no limit switches, both rope end positions must be watched and supervised. The winch is a lightweight with its aluminium housing and easy to carry.

Features:

- For 1-Ph/230 Volt/ 50 Hz – other voltages also for other countries
- Includes 10 m pendant control cable
- Includes 3 m power supply cable and country version plug
- Motor protection IP 44
- Control IP 65, splash water protected, with emergency stop button.

TYPE	PLA-B200	PLA-B300
Max. capacity in all rope layers	kg 200	300
Rope speed with full load	m/min 11 - 16	16 - 25
Tension	1-Ph / 230 V / 50 Hz	1-Ph / 230 V / 50 Hz
Motor data	1.5 kW, 25% ED-S3, FEM 1 Am, 12 A	2.3 kW, 25% ED-S3, FEM 1 Am, 11 A
Possible lifting height/Pulling length	m 70	29
Rope diameter x length	mm x m 5 x 71	6 x 30
Wire rope construction	6 x 19, 1770 N/mm ²	6 x 19, 1770 N/mm ²
A (Dimensions)	mm 94	94
B	mm 135 *	135 *
C	mm 210	210
D	mm 197	141
E	mm 205 *	151 *
F	mm 470	501
G	mm 270	270
H	mm 147	147
Weight complete with wire rope	kg 32	45
PLA-B Winch complete Order No.	H30170	H30171
CE-package for PLA-B ... Order No.	H30176	H30177

* = Please use as preferred option.



PLA-B200

Ready for use with rope and pendant control

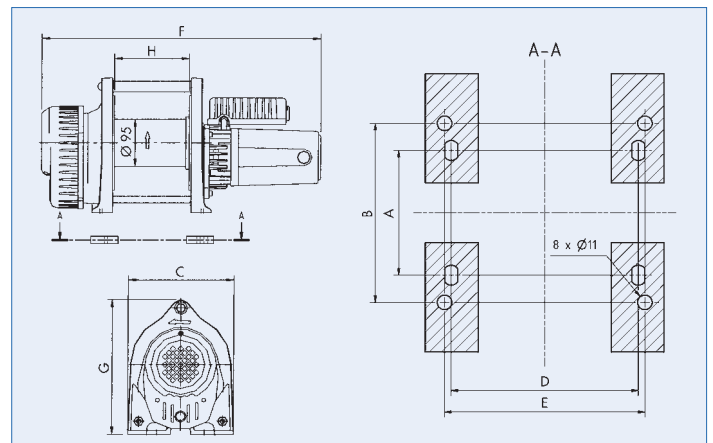

Electric winch PLA-180B-V6 for wind energy towers

This winch is conceived for very large lifting heights in wind energy towers to lift up a tool case or small spare parts into the nacelle. The service man does not have to carry this load up the ladder or risks an overload of the elevator. PLA-180B-V6 is bottom-up attached to the ceiling (see drawing) and is running very fast.

Special features:

- Single phase motor works 1-Ph/230V/50 Hz/1.5 kW
- With short control cable
- With rubber buffer covering the load hook to protect tower walls outside
- All screws, nuts, bars etc. made of stainless steel
- Galvanized ground plate for strong base fixing
- External HENSEL power connection box
- Gear box with cooler fan
- Limit switch for highest hook position

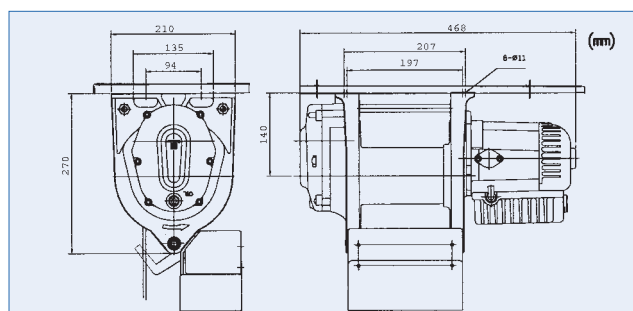

A lot of other solutions for the wind industry are available.

TYPE	PLA-180B-V6	
Max. capacity	kg	180
Standard lift	m	95
Lifting speed	m/min	18
Rope diameter (compressed)	mm	4.5
Class S3 duty cycle	ED	25 %
Weight with standard lift	kg	55
PLA-180B-V6 with 95 m lift	Order No.	H30173
PLA-180B-V6 without rope	Order No.	H30174